

Control equipment

EcoHeater Climatix

Quick Start Manual -
Climatix Control Unit

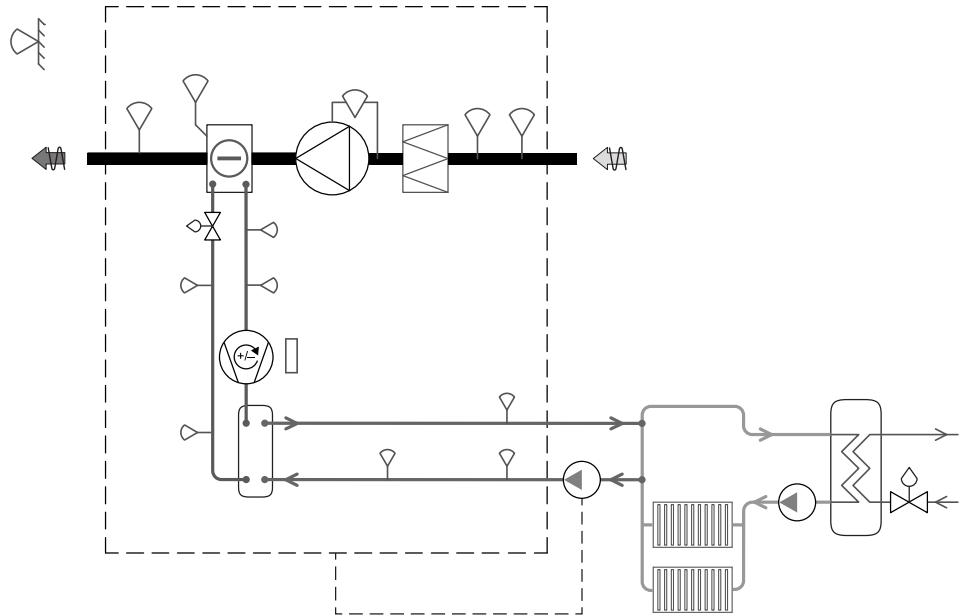

Air handling with focus on LCC

Table of Contents

1.	External control unit.....	3
2.	Functions	7
2.1	Global functions.....	7
2.2	Operating mode.....	8
2.3	Detailed pages for time control program.....	11
2.4	Weekly schedule.....	11
2.5	Daily schedule.....	12
2.6	Calendar (exceptions and stops).....	12
2.7	Temperature control, internal radiator curve	14
3.	Alarm	15
3.1	General.....	15
3.2	Alarm list information	17
3.3	Alarm list	17
3.4	Alarm history.....	17
3.5	Alarm and history list settings	18
4.	Commissioning of internal Modbus TCP	19
5.	Save and restore commissioning/factory settings	20
5.1	Save	20
5.2	Restore.....	20

1. External, control unit

Register:

The external control unit has the following register:

Hand-held unit

A. INFO
Explanation/help.
Switched off = Stop
Solid green light = Normal operation
Flashing green = Start-up, Night operation test, Night cooling or Night heating operation
Solid orange light = Emergency stop
Flashing orange = Fire damper exercise
Alternating green/orange = Off or Manual control.

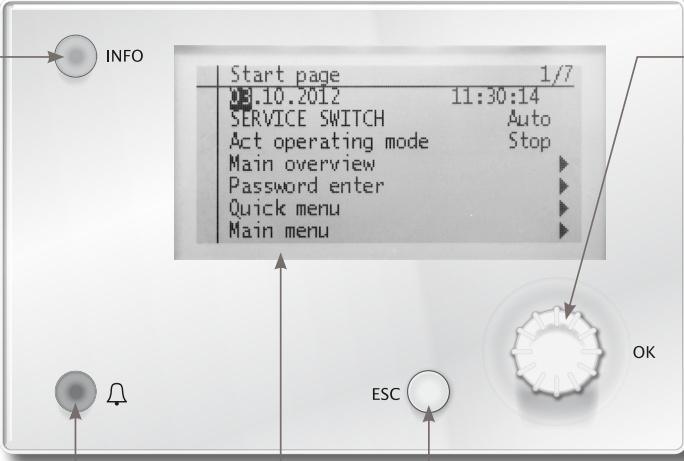

E. Navigation and OK button.
Turn clockwise or anticlockwise to *move down or up in the menus.*
Press to enter a menu, go to the next page or edit a value.
Turn to change value.
Keep pressed down to go straight to the login menu if the value you want to edit requires login.

B. ALARM
Flashing red with alarm.

C. Display window

D. ESC
Press once to return to previous menu/page, or to cancel edit in progress.

Login

To edit the most common parameters, e.g. setpoints, temperatures, etc., use login 1000 (basic authorisation level).

In the event that additional parameters and setpoints have to be edited, use login 2000 (normal authorisation level).

C. Screen

Display of menus, parameters, parameter values, operations, etc.

E. Adjustment dial

- Select menus, parameters, parameter values: **Turn.**
- Change parameter values: **Turn.**
- Go to sub-levels or settings pages: **Press.**
- Close settings pages and apply changed values: **Press.**
- Go to login page: **Keep pressed down.**

D. ESC button

- Go to higher level: **Press.**
- Close settings pages and discard changed values: **Press.**
- Return to previous page (after you have gone to the password management page via the adjustment dial): **Press.**
- Return to previous page (after you have gone to the main menu via the Info button): **Press.**

B. Alarm button

Light emitting diode (LED):

- Off: No alarm.
- Flashing: Alarm activated.
- Constant light: Alarm activated and acknowledged.

Press button to:

- Return to most recent alarm.
- Go to alarm list (displays activated alarm and alarm history).
- Go to alarm history.
- Go to alarm settings.
- Acknowledge and reset alarm in alarm list or alarm history.

Go to section 3 Alarms for more information about alarms.

A. Infobutton

- Go to the main menu and switch between main menu and start page:
Press.

Screen

Screen layout:

- a Current authorisation level:
 - No symbol: No authorisation level.
 - 1st key: basic authorisation level (Login: 1000)
 - 2nd key: normal authorisation level (Login: 2000)
 - 3rd key: technical authorisation level
- b Title of page displayed.
- c 7: Number of selected row: 16: Total number of rows on the page.
- d The page contains additional rows above that are displayed by scrolling upwards.
- e The page contains additional rows below that are displayed by scrolling downwards.
- f You can go to another level below this row.
- g Select row.

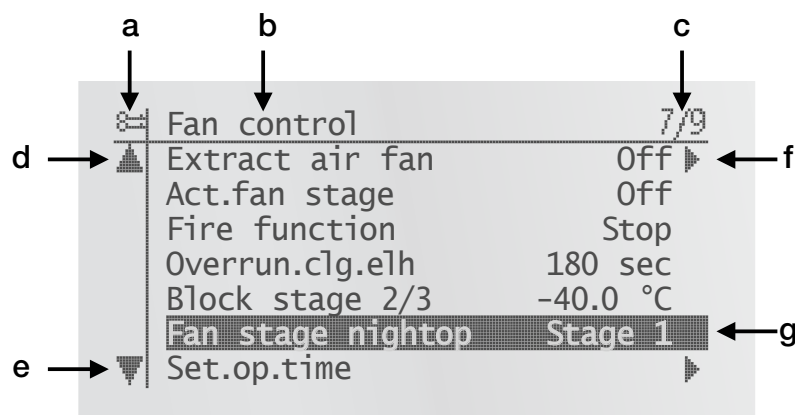

Navigation rows



The navigation rows display the alternative against a black background when it is displayed. The current value of the alternative is displayed in front of the navigation arrow.

Navigation:

- Select the row: **Turn the adjustment dial.**
- Go to the underlying level. **Press the adjustment dial.**

Display row



The alternative is also displayed against a black background when displayed in write-protected mode. The current value of the alternative is displayed.

Adjustment row



Parameter name and current value are displayed against a black background.

Setting a value:

- Select the row: **Turn the adjustment dial.**
- Change settings page: **Press the adjustment dial.**
- Set parameter value: **Turn the adjustment dial.**
- Close the settings page and apply the changed parameter value. **Press the adjustment dial.**
- Close the settings page and without applying the changed parameter value. **Press ESC.**

Setting discreet parameter values.

When only one value can be selected.



The set value is displayed on the row with an arrow in front (Setpoint fire). This is how to change the value:

- Select new value: **Turn the adjustment dial.**
- Apply the new value and close the settings page. **Press the adjustment dial.**
or
- Retain the old value and close the settings page: **Press the ESC button.**

When several values can be selected:

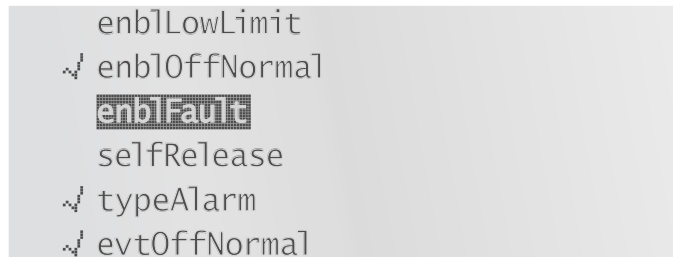

The set value is displayed on the rows with a tick in front. This is how to change the value:

- Select new value: **Turn the adjustment dial.**
- Select or deselect value: **Press the adjustment dial.**
- Apply the new value:
 - Select **Done: Turn the adjustment dial.**
 - Select **Done: Press the adjustment dial.**
- or
- Retain the old value and close the settings page: **Press the ESC button.**

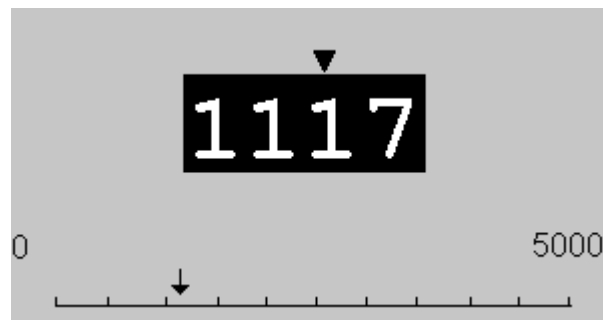

The scale displays the minimum and maximum values that can be set.

Change set value:

- Change the value below the arrow ▼: **Turn the adjustment dial.**
- Move the arrow to the left: **Turn the dial in increments of 10**
(9--->0 or 0--->9).
- Move the arrow to the right: **Do not turn the dial for at least one second.**
- Apply the new value and close the settings page. **Press the adjustment dial.**
or
- Retain the old value and close the settings page: **Press the ESC button.**

2. Functions

2.1 Global functions

2.1.1 General

This section describes the general functions in the application.

Preconditions None.

Parameter **Main menu > General functions**

Parameter	Value	Function
Manual operation	<ul style="list-style-type: none"> – Auto. – Manual 	<p>Shows whether any of the outputs are not in auto mode (control via control unit), whether any sensor is disabled or whether operating mode is not set to automatic operation.</p> <p>Go to the page for all settings, for example alarm class for enabled manual alarm.</p> <ul style="list-style-type: none"> – Auto mode: No object is controlled manually or is disabled. – Manual mode. At least one object is controlled manually or is disabled.
Enable manual alarm	<ul style="list-style-type: none"> – No – Yes 	<p>Enable alarm of Manual operation = Manual.</p> <ul style="list-style-type: none"> – No alarm. – Alarm enabled.
Enable comm. test		This function is not available.
Communication test		This function is not available.

2.2 Operating mode

2.2.1 General

Purpose	Function for setting and displaying all settings for current operating mode, i.e. starting conditions, switch-off conditions and operating mode. The AHU can also be controlled via the control unit.
Preconditions	None.
Parameter settings	None. Configuration in Configuration 1 and Configuration 2 specifies various methods of switching on the AHU.

View/settings **Main menu > Unit > Operating functions**

Parameter	Value	Function
Current	<ul style="list-style-type: none"> – Off – On – Damper motion – Fire – Stop – Start-up 	Operating mode: <ul style="list-style-type: none"> – Switched off. – Comfort mode. – Fire damper test. – Fire mode (depending on parameter setting for fire mode). – AHU stopped and blocked (regulator in start phase, configuration not complete, alarm class danger, emergency stop). – AHU's start-up procedure enabled.
Schedule	<ul style="list-style-type: none"> – Off – Step 1...Step 3 	Displays current control for timer control program (only if Timer control prog. funct. = Step). Go to the page for setting parameters of time control program.
From BMS	<ul style="list-style-type: none"> – Auto. – Off – Step 1 – Step 2 – Step 3 	Displays control from BVMS (only if Time control prog. funct. <> Step+Temp). The value can be set via the control unit even when communication is disabled. <ul style="list-style-type: none"> – Auto mode: AHU can be switched in via time control program, etc. – AHU switched off. – AHU operation in step 1 (uses setpoint value 1 for analogue outputs). – AHU operation in step 2 (uses setpoint value 2 for analogue outputs). – AHU operation in step 3 (uses setpoint value 3 for analogue outputs).
External control	<ul style="list-style-type: none"> – Auto. – Off – Step 1 – Step 2 – Step 3 	Displays current control from external control. <ul style="list-style-type: none"> – Auto mode: AHU can be switched on via time control program, timer, etc. – AHU switched off. – AHU operation in step 1 (uses setpoint value 1 for analogue outputs). – AHU operation in step 2 (uses setpoint value 2 for analogue outputs). – AHU operation in step 3 (uses setpoint value 3 for analogue outputs).
Power up delay	0...36000 [s]	Delayed start after restart of regulator.

2.2.2 Control of exhaust air fan

Function

Fan can be pressure-controlled or flow-controlled.

Fan can include alarm and/or connection for active feedback.

Up to three observable setpoints per fan can be defined as standard for controlled fans.

Operating time is specified separately. A message can be triggered when a specified number of operating hours has been reached for the exhaust air fan.

Parameter settings

Main menu > AHU > Fan control > Exhaust air fan

Parameter	Value	Function
Current value	xx [l/s], [Pa]	Depending on the type of control (Fan control type), for example current pressure value.
Regulator	0...100 [%]	Current regulator value. Go to the page for all regulator settings
Output	0...100 [%]	Current value of output. Go to page for all analogue output settings.
Control	<ul style="list-style-type: none"> – Off – Step 1 – Step 2 – Step 3 	Current fan mode. Go to page for all modulated digital output settings.

Main menu > AHU > Fan control > Exhaust air fan > Setpoints/Settings

Parameter	Value	Function
Current fan step	<ul style="list-style-type: none"> – – Off – Step1 – Step2 – Step3 	Current fan mode. <ul style="list-style-type: none"> – Off – Step 1 (setpoint 1) active. – Step 2 (setpoint 2) active. – Step 3 (setpoint 3) active.
Current setpoint exhaust air	0...100 [%] 0...40'000 [l/s] 0...5000 [Pa]	Depending on type of control (Fan control type <> Direct or Dir.var.): Current calculated fan setpoint.
Step 1	0...100 [%] 0...40'000 [l/s] 0...5000 [Pa]	Depending on type of control (Fan control type <> Direct or Dir.var.): Setpoint for step 1 (Time control prog. step >= 1 for controlled fans).
Step 2	0...100 [%] 0...40'000 [l/s] 0...5000 [Pa]	Depending on type of control (Fan control type <> Direct or Dir.var.): Setpoint for step 2 (Time control prog. step >= 2 for controlled fans).
Step 3	0...100 [%] 0...40'000 [l/s] 0...5000 [Pa]	Depending on type of control (Fan control type <> Direct or Dir.var.): Setpoint for step 3 (Time control prog. step = 3 for controlled fans).
Max. forced flow	0...(100 – highest setp.) [%] 0...(40'000 – highest setp.) [l/s] 0...(5000 – highest setp.) [Pa]	Depending on type of control (Fan control type <> Direct or Dir.var.): Highest possible setpoint Setpoint for highest step + Max. forced flow [%], [l/s], [Pa] (see also Fan compensation).
Min. run time	0...36000 [s]	Minimum run time for fan after start.
Deviation alarm	<ul style="list-style-type: none"> – Passive – Active 	Conditions: Fan control type <> Direct, Dir.var. or Fixed freq. Current mode for setpoint or current value for monitoring supply air pressure or supply air volume. Go to the page for supply air monitoring. <ul style="list-style-type: none"> – No alarm. – Alarm activated.

2.2.3 Manual control of outputs.

Function	Supply air fan, exhaust air fan, heat recovery, cooling, etc, can be controlled manually by setting each input and output.
Parameter settings	Main menu > AHU > Outputs > Digital outputs/Manual outputs
Digital	Fan, Heat pump, etc. Manual control > Select <i>ON</i> , <i>OFF</i> or <i>STEP</i> Current value changing, lamp flashes Return: <i>Manual control</i> > Select <i>ZERO</i> .
Analogue	Fan, Output signal heat pump, etc. Manual control % > Select (set desired output). Manual control changing to <i>Active</i> , and lamp flashes. Return: Select <i>Manual control Active</i> and change to <i>ZERO</i> .
Reset all	<i>ZERO</i> means that the output is controlled by the program's parameters and functions. <i>Active</i> means that the output is set manually. Lamp flashes when an output is controlled manually. Reset by changing <i>Active</i> to <i>ZERO</i> or by selecting Main menu > General functions > Reset I/O to Auto > select <i>Auto</i> and confirm (OK).

2.3 Detailed pages for time control program

This section describes functions and setting for time control programs and calendars.

Possible values vary, depending on the configuration. This is done in Configuration 1:

Main menu > Configuration > Configuration 1 > Time control prog. funct.

Main menu > Configuration > Configuration 1 > Time control prog. step.

Aux time control program

Off or On can be specified for the aux time control program:

Main menu > Configuration > Configuration 2 > Aux. time control prog.

Function

If no object with a higher priority (for example Manual control <> Auto) is enabled, the AHU can be switched off or step-changed (for frequency-controlled fans to the specified setpoint) via the time control program. A maximum of six switching times per week may be specified.

Calendar stop ignores calendar exceptions, which in turn ignores the normal time control program (only in operating mode). Up to ten periods or exception days can be specified for each calendar.

2.4 Weekly schedule

Parameter

Quick menu > Time control program > Schedule

Main menu > Unit > Operating functions > Time control program > Schedule

Parameter	Value	Function
Current value	---	Switching in accordance with schedule or selected mode for continuous operation.
Continuous operation	No Step1 Step2 Step3	<i>Continuous operation</i> function switched off. The AHU runs according to the time control program's schedule. The AHU runs constantly on operating step 1. The AHU runs constantly on operating step 2. The AHU runs constantly on operating step 3.
Monday		Displays current control if current day is Monday. The latest time that can be specified for a day is 23:59. Go to daily switching schedule for Mondays.
Copy schedule	Mon to Tue-Fri Tue-Sun	Copies times for time control program from Monday to Tuesday-Friday: Passive (no copying). Copying starts Return to display screen. Copying starts Return to display screen.
Tuesday		Same function as for Monday.
...		...
Sunday		Same function as for Monday.
Exception		Displays current control if current day is an exception day. Go to daily switching schedule for exception days.
Period:Start		(<i>Technical authorisation level only.</i>) Start date for weekly schedule. ** *.00 means that the weekly schedule is always enabled. ---> Enable weekly schedule.
Period:End		(<i>Technical authorisation level only.</i>) Start date and start time for disabling weekly schedule.

2.5 Daily schedule

Parameter

Parameter	Value	Function
Current value	---	Switching according to schedule is current weekday is the same as the switching day.
Daily schedule	– Active	Status of current week or exception day. – Current weekday (system day) is same as switching day.
Time 1		Special case: This time must not be changed, but must always be 00:00.
Value-1		Switching control for Time-1.
Time 2		Switching time 2. *: * ---> Time disabled.
Value-2 ... Value-6		Analogue value 1.
Time-3 ... Time-6		Analogue time 2.

2.6 Calendar (exceptions and stops)

Exception days can be defined in the calendar. These can include specific days, periods or weekdays. Exception days ignore the weekly schedule.

Calendar exceptions

Switching takes place in accordance with the weekly schedule and the exceptions specified in the daily schedule if a switching time is enabled in the calendar exception.

Calendar stops

The AHU is switched off when Calendar stop is enabled.

- **Main menu > Unit > Operating functions > Time control program > Calendar exceptions**
- **Main menu > Unit > Operating functions > Time control program > Calendar stops**
- **Main menu > Unit > Auxiliary > Time prog. output > Calendar exceptions**

Parameter	Value	Function
Current value	– Passive – Active	Shows whether a calendar time is enabled: – No calendar time enabled. – Calendar time enabled.
Select-x	– Date – Interval – Weekday – Passive	Specification of exception type: – A certain day (e.g. Friday). – A period (e.g. holiday). – A certain weekday. – Times are disabled. This value must always be placed at the end, after the date.
-(Start)Date		– Select-x = interval: Specify start date for the period. – (Select-x = date: Specify specific date.)
-End date		Select-x = interval: Specify end date for the period. The end date must be later than the start date.
-Weekday		Select-x = weekday only: Specify weekday.

Only time of (start) is relevant.

- -(Start)Date = *,01.01.09
Result: 1 January 2009 is an exception date.
- -(Start)Date = Mo,*.*.00
Every Monday is an exception date.
- -(Start)Date = *,*.Even.00
All days in even months (February, April, June, August, etc.) are exception days.

Example:

Selection-1 = Interval

The times for (Start)Date and End date are applied.

- -(Start)Date = *,23.06.09 / -End date = *,12.07.09
23 June 2009 until 12 July 2009 are exception days (e.g. holiday).
- -(Start)Date = *,23.12.00 / -End date = *,31.12.00
23-31 December is an exception period every year. The time End date = *,01.01.00 does not work, as 1 January occurs before 23 December.
- -(Start)Date = *,23.12.09 / -End date = *,01.01.10
23 December 2009 until 1 January 2010 are exception days.
- -(Start)Date = *,00 / -End date = *,00
Warning! This means that exceptions are always active! The AHU is continuously in exception mode or switched off.

Example:

Selection-1 =Weekday

The times for weekday are applied.

- Weekday = *,Fr,*
Every Friday is an exception day.
- Weekday = *,Fr,Even*
Every Friday in even months (February, April, June, August, etc.) is an exception day.
- Weekday = *,*
Warning! This means that exceptions are always active! The AHU is continuously in exception mode or switched off.

2.7 Temperature control internal radiator curve

Preconditions

Only displays function that is enabled in Configuration 1. All other functions are hidden.

Parameter settings

Main menu > Unit > Setpoints/Settings

Parameter	Value	Function
Outside	- - -	Current temperature used for control. Outdoor temperature
X2 OutdoorT. Setpoint	-64 – 99°C	Lowest outdoor temperature 2
Y2 Exp. Setpoint Temp.	-64 – 79°C	Highest supply line temperature 2
X3 OutdoorT. Setpoint	-50 – 25°C	Breaking point outdoor temperature 3
Y3 Exp. Setpoint Temp.	-0 – 130°C	Breaking point supply line temperature 3
X4 OutdoorT. Setpoint	-50 – 25°C	Breaking point outdoor temperature 4
Y4 Outdoor Temp Setpoint	-0 – 130°C	Breaking point supply line temperature 4
X5 OutdoorT. Setpoint	-50 – 25°C	Breaking point outdoor temperature 5
Y5 Exp. Setpoint Temp.	-0 – 130°C	Breaking point supply line temperature 5
X6 OutdoorT. Setpoint	-64 – 99°C	Highest outdoor temperature 6
Y6 Exp. Temp Setpoint	-64 – 99°C	Lowest supply line temperature 6
Current setpoint VP	- - -	Current calculated supply line setpoint
Supply line Temp. VP	- - -	Current temperature used for control, supply line temperature.

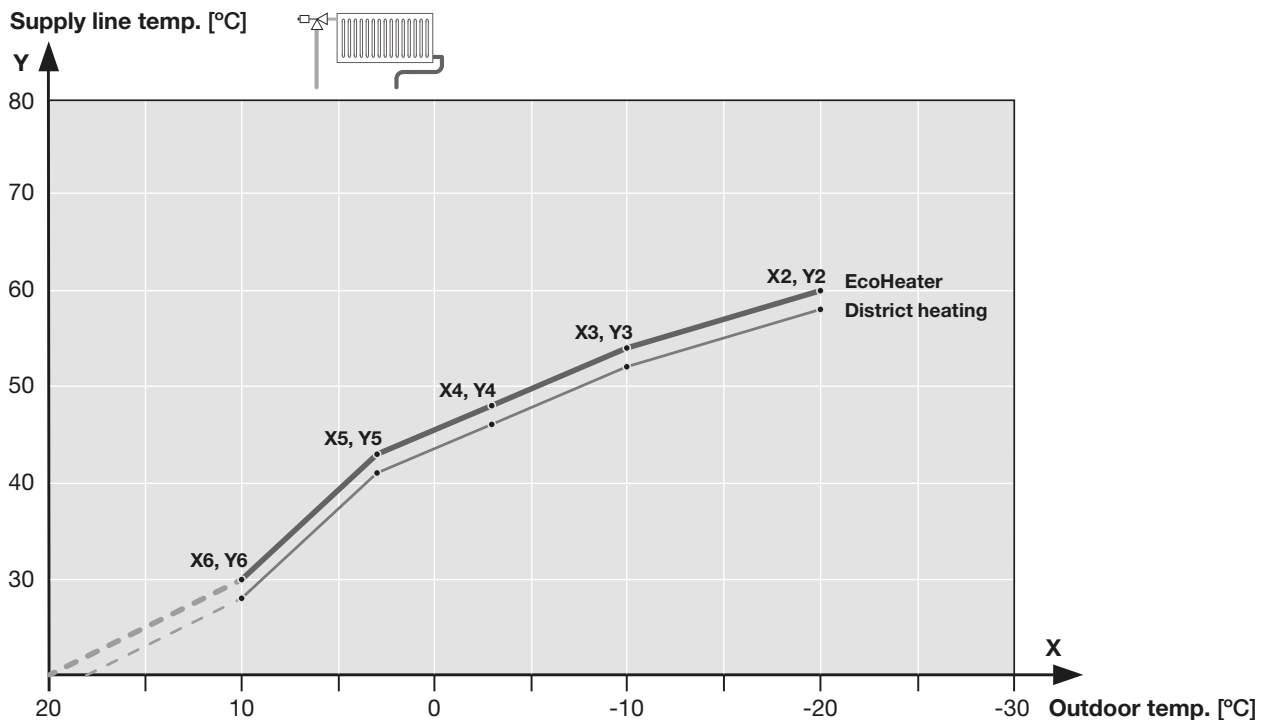

3. Alarms

3.1 General

This section described the following functions:

- Alarm.
- Alarm lists.
- History lists.
- Acknowledge alarms.
- Reset alarms.

Principles

- Alarm and history lists can contain a maximum of 60 entries.
- Each alarm entry includes description, notification class, alarm group, date and time.
- Every new alarm generates an entry in the alarm list and in the history list.
- Active alarm:
 - The alarm indicator on the external control unit flashes.
 - The alarm symbol in the built-in control unit flashes.
- Alarm acknowledged but still active:
 - The alarm indicator on the external control unit lights up.
 - The alarm symbol in the built-in control unit lights up.
- Alarm reset:
 - Alarm list: the alarm entry is removed.
 - History list: the alarm entry is displayed as removed.

Alarm that retains or releases values Procedure for alarm that releases values:

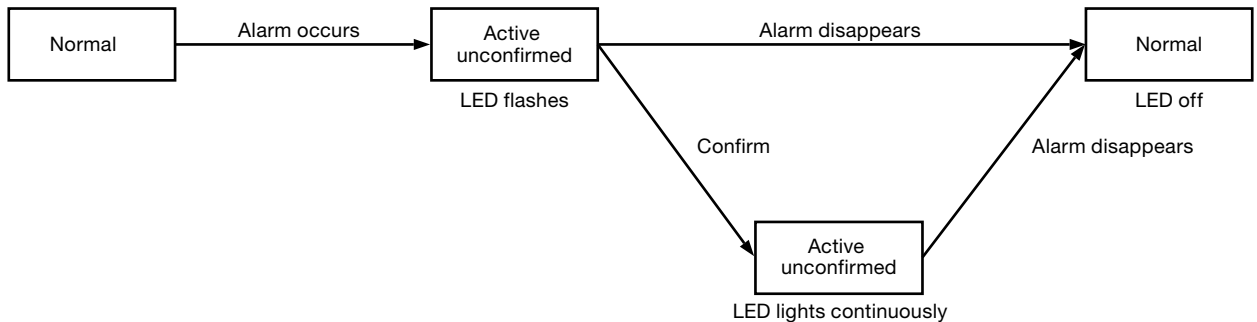

Procedure for alarm that retains values:

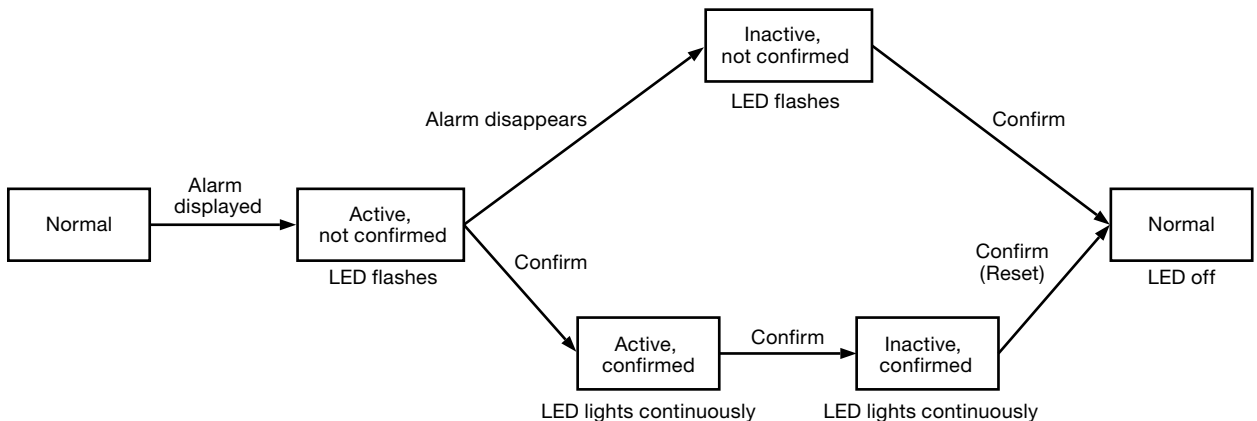

Alarm button function

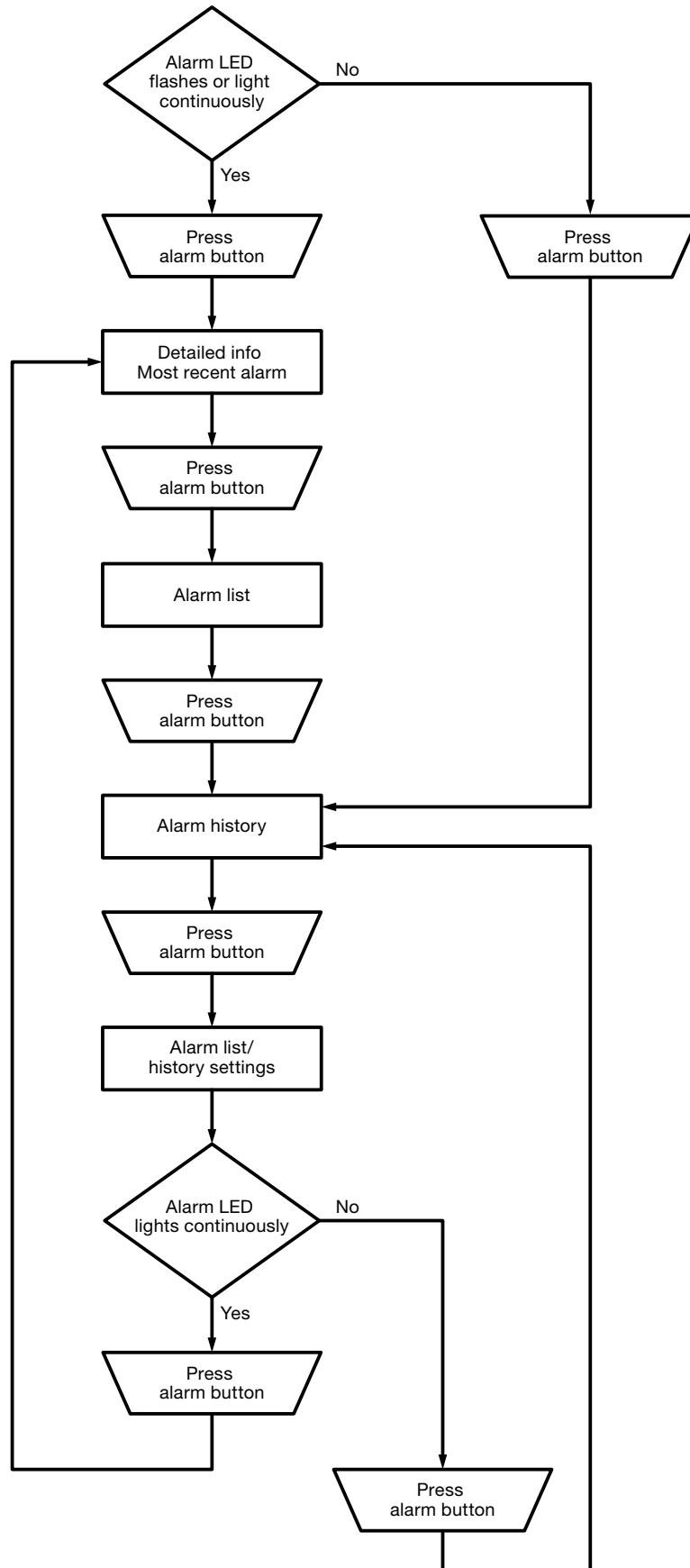

Alarm list information

The alarm list contains the following information about the most recent alarm:

Row 1	+ Alarm name	Status
Row 2	Notification class	(Notification group)
Row 3	Date	Time
Example:	+Exhaust air temp. heat: 0 15.10.2009	Alarm Alarm low (B) 21:32

3.2 Alarm list

The following information about active alarms is included in the alarm list:

Row 1	Number of alarms not yet acknowledged: Acknowledged Passive number. Example: Acknowledged Passive 14 Press control unit's adjustment dial to acknowledge all unacknowledged alarms.
Other rows	+ Alarm name Status Example: + Exhaust air temp.: Alarm – Press the adjustment dial to display detailed information about the alarm. – Press the alarm button to display the list settings.

NB: The list can contain up to 50 entries.

3.3 Alarm history

The following information about active and passive alarms is included in the alarm list:

Row 1	Number of alarms not yet reset: Acknowledged Passive number Example: Acknowledged Passive 14 Press control unit's adjustment dial to acknowledge all unacknowledged alarms.
Other rows	+ Alarm name: Status Example: + Exhaust air temp.: Alarm (notified alarm). - Exhaust air temp.: OK (alarm removed). – Press the adjustment dial to display detailed information about the alarm. – Press the alarm button to display the list settings.

NB: The list can contain up to 50 entries.

3.4 Alarm and history list settings

Parameter	Value	Function
Alarm list		
Reset		Reset/acknowledgement of ongoing alarm.
Sort 1	<ul style="list-style-type: none"> – Time – Name – Class – Status 	Primary sort criterion: <ul style="list-style-type: none"> – Sort by date and time. – Alphabetical search in ascending order. – Sort by notification class (0, 1, 2, 3 corresponding danger/prioritised/unprioritised/warning). – Sort by status (fault/no fault).
Sort 2	<ul style="list-style-type: none"> – Time – Name – Class – Status 	Secondary sort criterion: See sort order 1.
Descending	<ul style="list-style-type: none"> – Passive – Active 	Alarms sorted in ascending or descending order. <ul style="list-style-type: none"> – Ascending. – Descending.
Alarm history		
Reset		Deletion of the history list.
Sort 1	<ul style="list-style-type: none"> – Time – Name – Class – Status 	Primary sort criterion See Alarm list.
Sort 2	<ul style="list-style-type: none"> – Time – Name – Class – Status 	Secondary sort criterion: See Alarm list.
Descending	<ul style="list-style-type: none"> – Passive – Active 	See Alarm list.
Last entry		See Alarm list.

4. Commissioning of internal Modbus TCP

Units involved

The figure shows which units and connections are involved for commissioning:

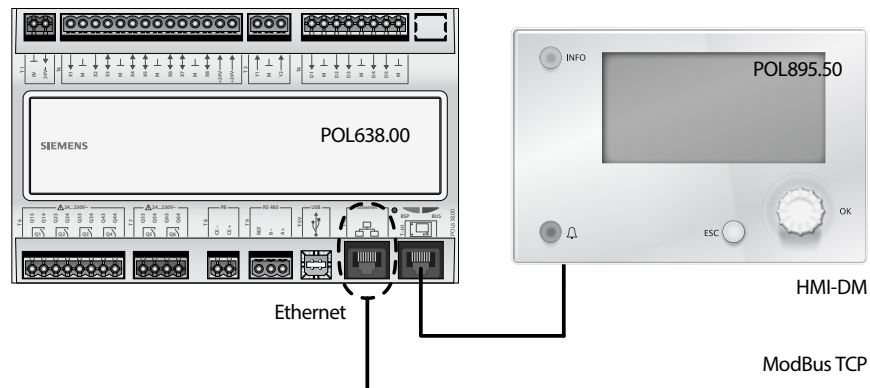

Connection

Connect Climatix control unit to Ethernet (Modbus TCP) using a standard network cable.

Configuration via hand-held unit

Proceed as follows to configure the unit for internal Modbus TCP:

Step	Action
1	Log into the hand-held unit using password 2000.
2	Select Main menu > System summary > Communication > Modbus >
-	Internal Modbus: Decide whether the integrated Modbus interface RS485 is to be used as Master or Slave. This does not affect Modbus TCP.
3	Select Internal slave address: Set the correct Modbus slave address (1...247). Warning! This also applies to Modbus RTU.
4	Select Internal settings for TCP/IP > NB: Settings for TCP/IP can also be viewed - and changed here: Main menu > System summary > Communication > TCP/IP >
-	Make sure that you change the TCP/IP settings if the control unit is already connected to the Ethernet for any other purpose.
5	Select DHCP (normally Passive): Active, DHCP server issues addresses. Passive, IP address is fixed.
6	Select Set IP: Specify the control unit's IP address if DHCP is set at Passive.
7	Select Set Mask: Specify subnet mask if DHCP is set at Passive.
8	Select Set Gateway: Specify the control unit's gateway address if DHCP is set at Passive.
9	Select Restart: Use this command to restart the control unit when you have finished.

After restart, internal Modbus TCP is configured and ready for use.



The general rule is that the control unit must be restarted using "Restart" or by switching the power to the unit off and on after changes in order that the new settings will apply.



Settings other than the above have nothing to do with Modbus RTU in slave operation and should not be changed.

5. Save and restore commissioning/factory settings

After settings and adjustments have been made, parameters and settings should be saved in both the internal memory in the Climatix control unit and in the SD memory so that they can be restored after any loss of data.

5.1 Save

5.1.1 Commissioning settings

Parameter settings

Main menu > System summary > Save/Restore >

Select **Save comm. settings > Execute**. Current settings are saved to the internal memory in the main unit.

5.1.2 SD memory settings

Parameter settings

Main menu > System summary > Save/Restore >

Insert an SD memory in the main unit's memory card reader. Select **Save param. to SD > Execute**. Current settings are saved to SD:

NB: Existing parameters on the SD card will be overwritten with the new ones.

5.2 Restore

5.2.1 Commissioning settings

Parameter settings

Main menu > System summary > Save/Restore >

Select **Restore comm. settings. > Execute**. Most recently saved settings are restored from the internal memory in the main unit to active current settings.

5.2.2 Settings from SD memory.

Parameter settings

Main menu > Configuration > Configuration via Download

RESTART - The unit restarts on its own if the alternative is changed from **HMI** to **Download** or vice versa. When the unit has restarted, proceed to:

Main menu > System summary > Save/Restore >

Insert the SD memory with the saved settings in the main unit's memory card reader. Select **Download param. from SD > Execute Full**. The saved settings on the SD card are downloaded to active current settings in the control unit. After this a restart is required:

Main menu > System summary > Save/Restore > Restart.

5.2.3 Restore factory settings

Parameter settings

If you need to return to the settings with which the unit was delivered from the factory, this is how to restore the factory settings:

Main menu > System summary > Save/Restore >

Select **Restore factory settings. > Execute**. The saved factory settings in the internal memory are downloaded to active current settings in the control unit.

RESTART - The unit restarts itself once **Execute** has been selected.

After this automatic restart an additional restart should be performed:

Main menu > System summary > Save/Restore > Restart.

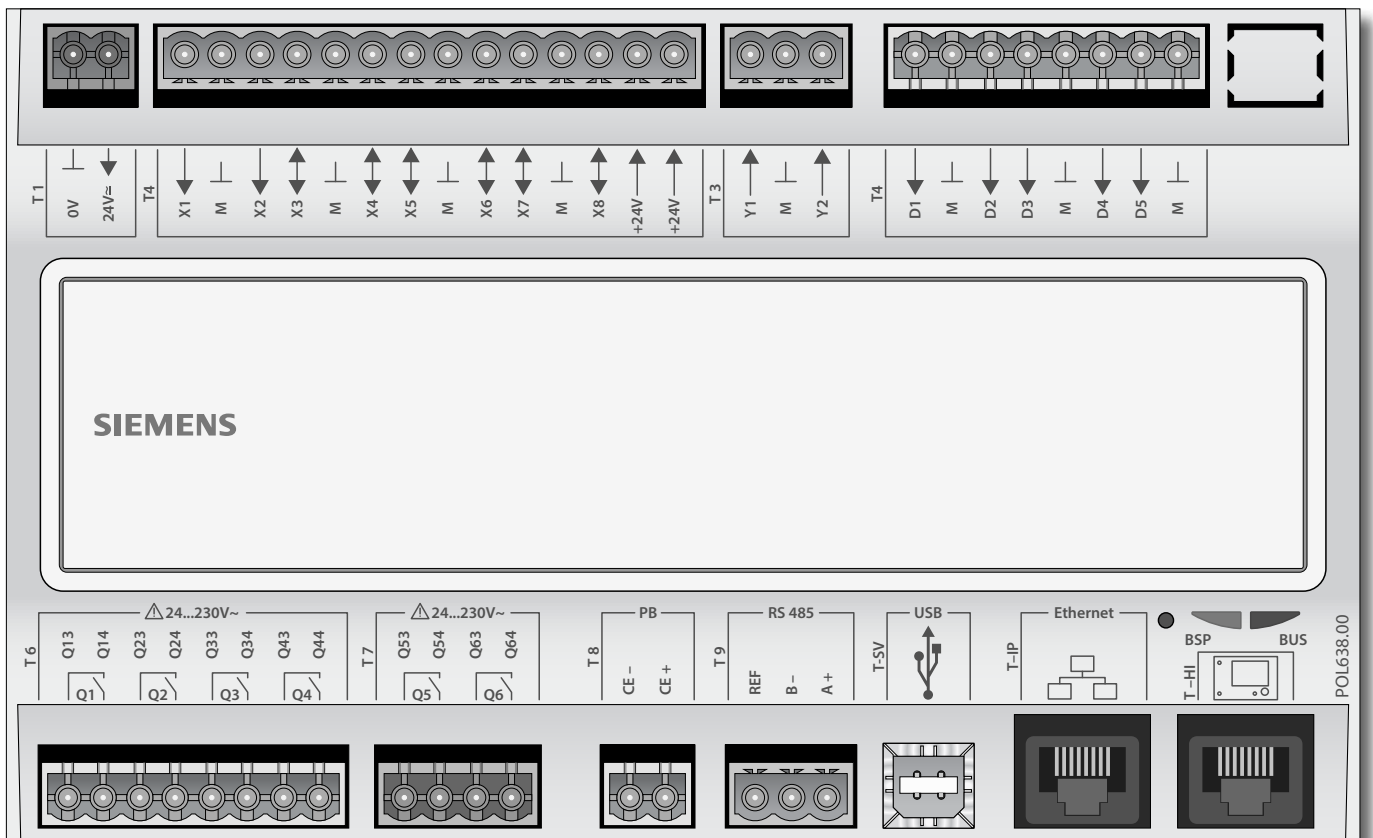
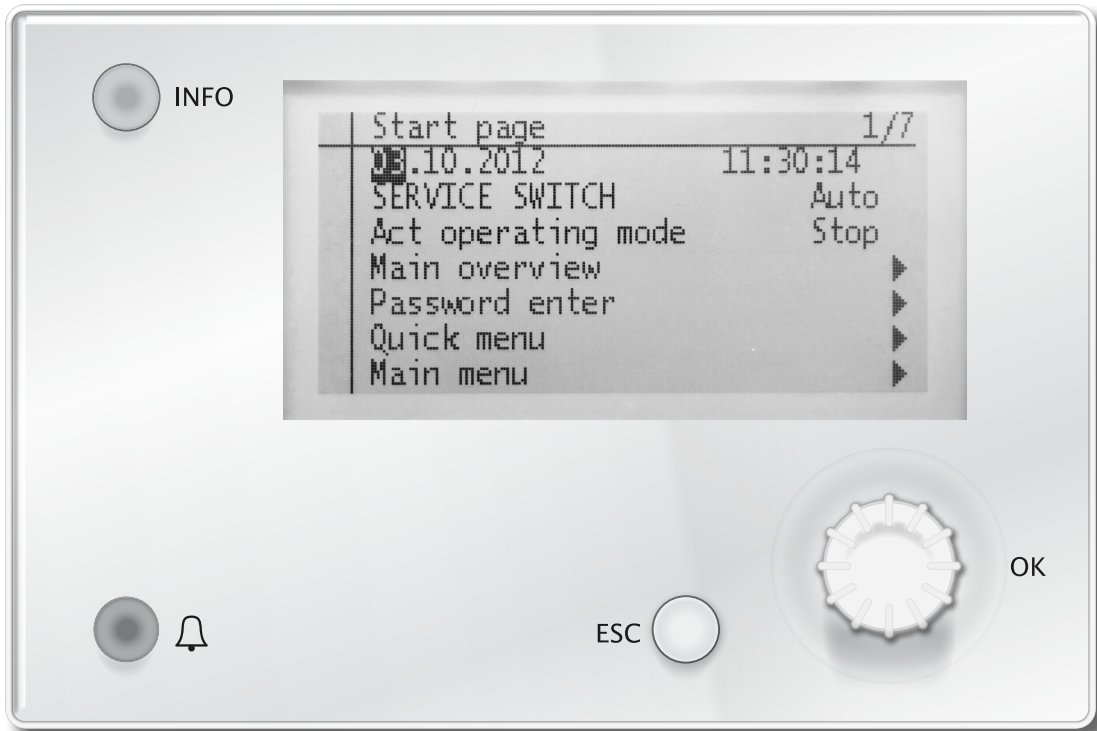



Air handling with focus on LCC

IV Produkt AB, Box 3103, SE-350 43 Växjö • SWEDEN
Phone: +46 (0)470 - 75 88 00 • Fax: +46 (0)470 - 75 88 76
info@ivprodukt.se • www.ivprodukt.se

18710-6011 SMCX.151008.00EN

